



INVERTER HEAT PUMP FOR SWIMMING POOLS

INSTALLATION & OWNER'S MANUAL

Models Covered:

PHP-50

PHP-65

PHP-90

PHP-110

PHP-140



VERSION DATE: 08-22-24

Content

I.	Application	3
II.	Features.....	3
III.	Technical Parameter	4
IV.	Dimension.....	5
V.	Installation instruction	6
VI.	Operation instruction.....	10
VII.	Advanced application.....	13
VIII.	Timer	16
a)	Timer on setting	17
b)	Timer off setting.....	18
IX.	Testing.....	19
X.	Precautions	20
XI.	Maintenance.....	21
XII.	Trouble shooting for common faults	22
XIII.	Wi-Fi Setting.....	24
XIV.	Warranty & After-Service.....	33

Special Attention:

- A. This product is only for swimming pool water heating applications and can't be used for the heating for any other liquid materials.
- B. The inlet and outlet water nozzles can't bear the weight of external pipes.
- C. The main power switch should be out of the reach of children.
- D. Make sure the power is switched off before opening the case of the product.

This appliance is not intended for use by persons (including children) with reduced physical, sensory or mental capabilities, or lack of experience and knowledge, unless they have been given supervision or instruction concerning use of the appliance by a person responsible for their safety.

NOTE:

- A. The swimming pool heat pump must be installed by a qualified electrician. These regulations may change depending on the Country, Province or State you live in.
- B. To maximize your swimming comfort, set proper heating temperature. The recommended heating temperature is 85°F. The unit can work above and below this recommendation up to a specific capacity depending on operating conditions. Please contact support for more information.
- C. Don't put obstacles near the air inlet and outlet of the heat pump.
- D. This heat pump has power-off memory function.
- E. When the ambient temperature is below 3°C, make sure to switch off the main power, and drain off the water from heat exchanger.
- F. Never place your hand or any other object in the air inlet or outlet of the heat pump.
- G. If any abnormal circumstances discovered, ex: abnormal noise, smells,

smokes and leakage of electricity, switch the main power off immediately and contact your local dealer/installer or support directly. Do not try to repair the heat pump yourself.

I. Application

- 1- Set swimming pool water temp efficiently and economically to provide you comfort and pleasure.
- 2- User may choose the model based off technical parameters presented in this manual. This series of swimming pool heater has been optimized in factory (refer to technical parameter table).

II. Features

- 1- Sensitive and accurate temp control and water temp display.
- 2- High-pressure and low-pressure protection.
- 3- Protection in case of too low or no water flow
- 4- Exceeding low temp auto stop protection.
- 5- Temp control compulsory defrosting.
- 6- International brand compressor.
- 7- High efficient titanium heat exchanger
- 8- Easy installation and operation.

III. Technical Parameter

Model	PHP-50	PHP-65	PHP-90	PHP-110	PHP-140
Voltage	208-230V	208-230V	208-230V	208-230V	208-230V
Frequency/phase	60Hz/1Ph	60Hz/1Ph	60Hz/1Ph	60Hz/1Ph	60Hz/1Ph
Heating current (air80°F,water80°F) A	1.6-10.2	2.5-13.1	2.9~16.9	2.9~23.7	3.6~31.3
Heating power (air80°F,water80°F) kW	0.3-2.3	0.56-3.0	0.6~3.9	0.6~5.4	0.8~6.9
Design pressure (High)	≤609 PSIG	≤609 PSIG	≤609 PSIG	≤609 PSIG	≤609 PSIG
Design pressure (Low)	≤261 PSIG	≤261 PSIG	≤261 PSIG	≤261 PSIG	≤261 PSIG
Refrigerant(R410A) oz	38.8	47.6	98.8	141.0	176.4
Net weight Kgs	52	63	85	125	143
Water circulation flow L/min	83~117	108~142	125~158	133~167	133~254
Noise at 10Feet dB(A)	≤50	≤50	≤50	≤50	≤50
Waterproof class	IPX4	IPX4	IPX4	IPX4	IPX4

Notice:

1. This product works well under water temp 80°F to104°F, air temp 32°F to 109°F, efficiency will not be guaranteed out of this range. Please take into consideration that the pool heater performance and parameters are different under various conditions. Always refer to your pool expert on the correct unit for the size of your pool and your needs as these will vary depending on operating conditions. You may also contact support for confirmation.
2. Related parameters are subject to adjustment periodically for technical improvement without further notice. For details on your unit please refer to the nameplate on the product.

IV. Dimension

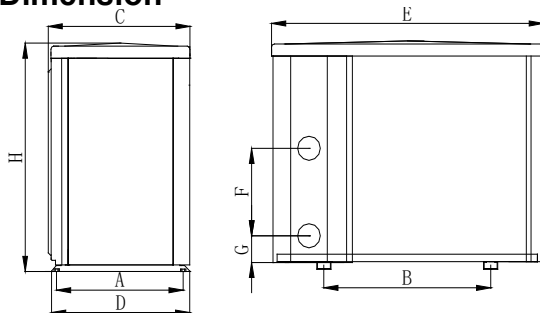

Size(inch) / Name / Model	A	B	C	D	E	F	G	H
PHP-50	12.4	23.2	12.3	13.4	37.8	13.0	2.9	25.9
PHP-65	15.6	23.2	15.4	16.5	37.8	14.2	2.9	29.8
PHP-90	15.6	28.3	15.4	16.5	43.0	24.4	2.9	37.7

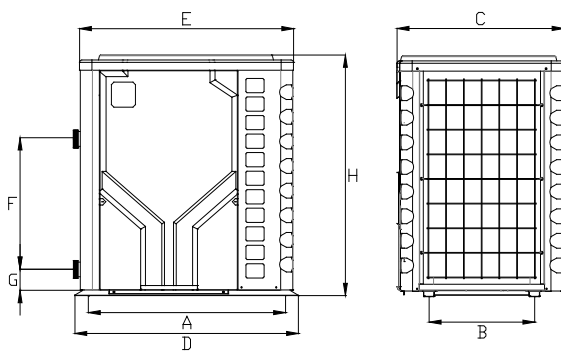

Size(inch) / Name / Model	A	B	C	D	E	F	G	H
PHP-110	36.3	17.6	35.6	37.2	27.8	20.9	3.3	38.5

PHP-140	39.8	20.5	32.3	40.8	39.2	20.9	3.3	41.5
---------	------	------	------	------	------	------	-----	------

※ Above data is subject to modification without notice.

Note:

The picture above is the specification diagram of the pool heater, for technician’s installation and layout reference only. The product is subject to adjustment periodically for improvement without further notice.

V. Installation instruction

1. Drawing for water pipes connection.

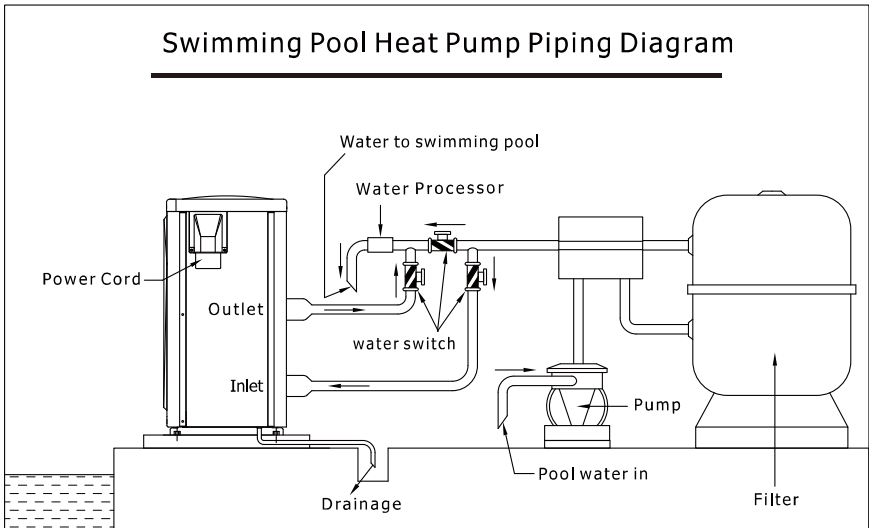

(Notice: The drawing demonstration and layout of the pipes is only for reference.)

2. Electric Wiring Diagram

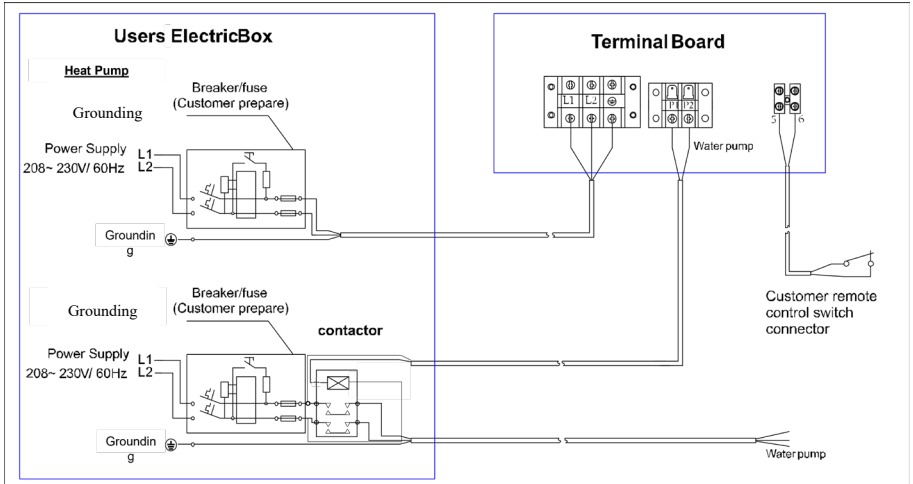

- Note: 1) ⚠️ Must be hard wired, no plug allowed.
 2) The swimming pool heater must be grounded.
 3) WARNING: Before obtaining access to terminals, all supply circuits must be disconnected.

Options for protecting devices and cable specification

MODEL		PHP-50	PHP-65	PHP-90	PHP-110	PHP-140
Breaker	Rated Current A	20	30	30	40	50
	Rated Residual Action Current mA	30	30	30	30	30
Fuse	A	20	30	30	40	50
Power Cord	(AWG)	2×12	2×10	2×10	2×8	2×8
Signal cable	(AWG)	2×20	2×20	2×20	2×20	2×20

※ Above data is subject to modification without notice.

Note: The above data is adapted to power cord $\leq 393.7\text{in}$. If power cord is $>393.7\text{in}$, wire diameter must be increased. The signal cable can be extended to 1968.5in at most.

3. Installation and Requirements

The swimming pool heater must be installed by a pool professional. End users are not qualified to install the heater. Damage may occur to the heater or threaten the safety of the user. Pool professional guidelines will vary depending on your country, state or province regulation and can include HVAC technicians or electricians. Warranty will be voided if done otherwise.

Notes:

- 1) The inlet and outlet water unions can't bear the weight of soft pipes. The heat pump must be connected with hard pipes!

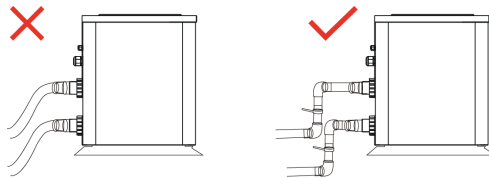

- 2) In order to guarantee the heating efficiency, the water pipe length should be $\leq 393.7\text{in}$ between the pool and the heat pump.

A. Installation

- 1) The swimming pool heater should be installed in a location with good ventilation;
- 2) The frame must be fixed by bolts (M10) to concrete foundation or brackets. The concrete foundation must be solid and fastened; the bracket must be strong and antirust treated;
- 3) Don't stack substances that will block air flow near inlet or outlet area, and no barrier within 20in behind the main heater, or the efficiency of the heater will be reduced or even halted;
- 4) The heater needs an appended pump (Supplied by the user). The recommended pump specification-flux: refer to Technical Parameter, Max. lift $\geq 393.7\text{in}$;
- 5) When the heater is running, there will be condensation water discharged from the bottom. Attach the drainage nozzle (accessory for PHP-50, PHP-65, PHP-90 models)

into the hole under the unit, then connect the pipe to drain the condensation water out.

B. Wiring

- 1) Connect to appropriate power supply; the voltage should comply with the rated voltage of the products.
- 2) Heater must be grounded.
- 3) Wiring must be handled by a professional technician respecting circuit diagram.
- 4) Infinity Living units do not require a GFCI to function. If required by code, please respect following guidelines.
 - i. Set GFCI according to the local code for wiring (current leakage $\leq 30\text{mA}$).
 - ii. Some GFCI breakers may cause nuisance trips with variable speed products.
Consult a certified electrician, your retailer or support to confirm wiring.
Product Warranty does not cover electrical wiring.
- 5) The layout of power cable and signal cable should be orderly and not interfere with each other.
- 6) The appliance shall be installed in accordance with national wiring regulations.

C. Switch on after finishing all wiring construction and re-checking.

Pay attention to the following points:

1. The heat pump must be installed OUTSIDE in a well ventilated area to avoid air recirculation, or in a place with adequate room for both installation and maintenance. Please refer to the following illustration for side fan models (PHP-50, PHP-65, PHP-90).
2. For top fan models (PHP-110, PHP-140), clearance above the unit should be 39.4" unobstructed and 20" around.



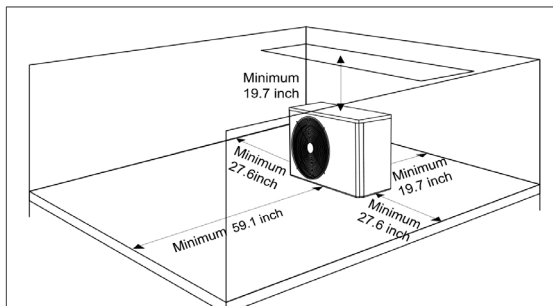

A minimum of 20" of clearance from walls, shrubbery, equipment, etc. is required around the entire pump circumference. This allows for ample air intake. No less than 39.4" clearance on the air outlet is required to prevent recirculation of air. We recommend to not place the unit underneath eaves, decks, or porches, as this causes recirculation of discharged air, or the efficiency of the heater will be reduced or even stopped.

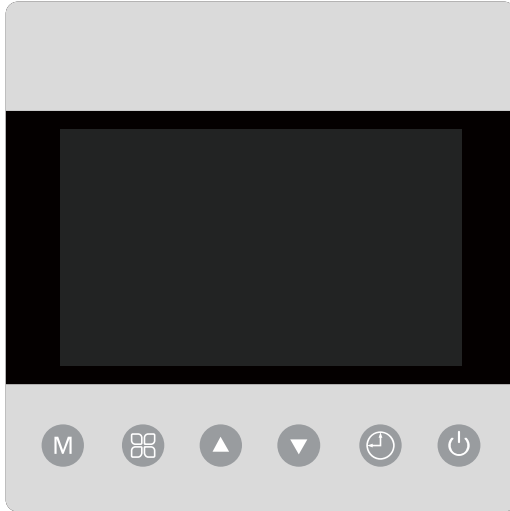

VI. Operation instruction

Picture for keys







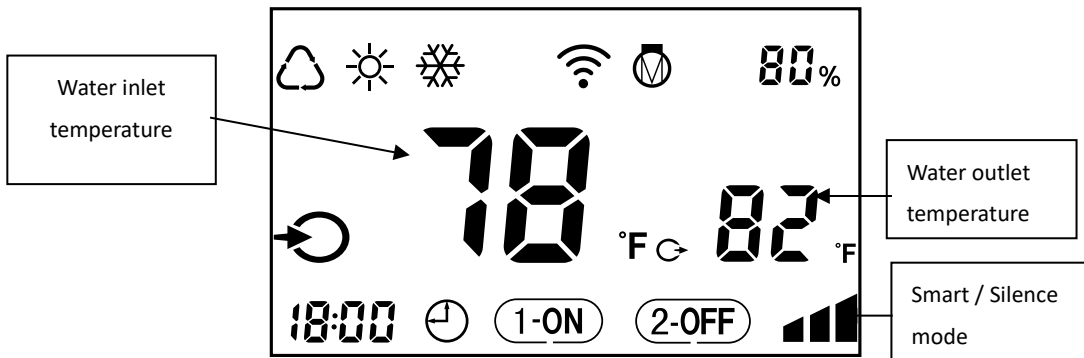

SYMBOL	DESIGNATION	FUNCTION
	ON / OFF	1. Power On / Off 2. Wi-Fi setting
	Mode	Heating 18°C~40°C Cooling 12°C~30°C Auto 12°C~40°C
	Speed	Select Smart / Silence mode
	Up / Down	Adjust set temperature

	Timer	Time and timer setting
---	-------	------------------------

Screen display

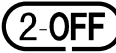

	Heating
	Cooling
	Auto
	Heating capacity percentage
	Wi-Fi connection
	Water inlet

	Water outlet
18:00	Time
  	Timer

Routine operation

1. If no operation in 30 seconds, screen will be locked and be dark, press any buttons to make screen on.

2. Power On/off: When the screen is on, press  to power on/off heat pump.







3. Mode Selection: Press  to select mode.

Auto  : adjustable temperature range 12~40°C





Heating  : adjustable temperature range 18~40°C

Cooling  : adjustable temperature range 12~30°C







4. Temperature setting:

When screen is unlocked, short press  or , the temperature setting value will be flashing, then short press  or  to add or subtract, long press  or  more than 0.5 seconds will increase or decrease rapidly, short press  or 5 seconds without operation will automatically exit the temperature setting state.

5. Smart/Silence mode selection:



- Press  to enter Smart mode, and screen shows , then press  to enter Silence mode, the screen shows .

6. Defrosting

- a. Auto Defrosting: When heat pump is defrosting,  will be flashing. After defrosting,  will stop flashing.
- b. Compulsory Defrosting: When heat pump is heating, press  and  together for 5 seconds to start compulsory defrosting, and  will be flashing. After defrosting,  will stop flashing.

Note: Compulsory defrosting intervals should be more than 30 minutes and the compressor should run for more than 10 minutes at heating mode.

7. Temperature display conversion between °C and °F:



Press  and  together for 5 seconds to switch between °C and °F.

8. Wi-Fi setting



Please kindly check the last page.

VII. Advanced application





2.3.1 Parameter Checking

- a. Press  and  together for 5 seconds to enter “Parameter Checking” status, the parameter code “P0” and

the parameter value “0” will display on the screen, such as “P0 0”, which means water pump running way is continuous.

- b. In “Parameter Checking” status, press  or  to check the parameters.

2.3.2 Parameter Modification





In “Parameter Checking” status, press  to enter the “Parameter Modification” mode, press  or  to change the values, then press  to confirm and quit “Parameter Modification” mode, press  to quit “Parameter Checking” status.

2.3.3 Parameter list

NO	Content	Adjust range	Step length
P0	Water Pump Running Way	0: Continuous 1: Water temp control 2: Time/water temp control	1
P1	Time Setting (Only available when the water pump running way is set to “2”)	10 ~ 120 min	5 min

P2	Compressor Continuously Running Time between Defrosting Mode	30 ~ 90 min	1 min
P3	Defrosting Entry Temp	-17~0°C / 1~32°F	1°C /1°F
P4	Maximum Defrosting Running Time	1 ~ 12 min	1 min
P5	Defrosting Exit Temp	8~30°C /46~86°F	1°C /1°F

2.3.4 Running status checking

Press  for 5 seconds, enter into “Running status checking”, and the screen alternately shows status point “C0” and its corresponding value. Check all status points and their corresponding value through  or  , Press  to quit “running status checking” mode.









Running status checking list

Symbol	Content	Unit
C0	Inlet water temp.	°C / °F
C1	Outlet water temp.	°C / °F
C2	Ambient temp.	°C / °F
C3	Exhaust temp.	°C / °F
C4	Outer coil pipe temp. (Evaporator)	°C / °F

C5	Gas return temp.	°C / °F
C6	Inner coil pipe temp. (Titanium heat exchanger)	°C / °F
C9	Cooling plate temp.	°C / °F
C10	Electronic expansion valve opening	P
C11	DC fan speed	(r/min)

VIII. Timer



The timer function is a 24-hour system, please calibrate with local time.

- a. Real time setting: Press  for 5 seconds to enter real time setting, short press  or  to adjust the value. Press and hold  or  for more than 0.5 seconds to increase or decrease rapidly, press  to confirm, press  to cancel the setting.
- b. Timer setting
Press  for 10 seconds and release to enter the timer setting, the timer icon will light up.

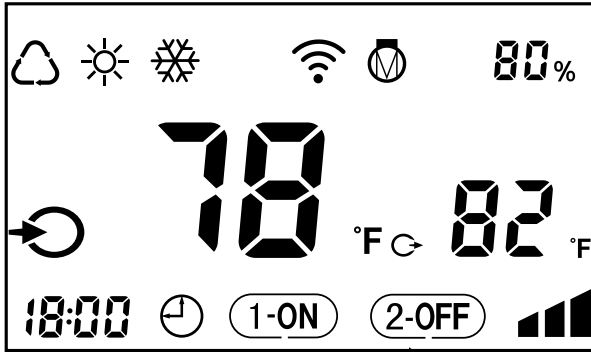
a) Timer on setting





1. Timer on flashing, press  to select timer on once / timer on cycle every day.

2. Press  or  to adjust the timing time, long press will increase or decrease rapidly.

3. Press  to confirm the operation and enter the timer off setting.

4. Press  to cancel the operation and exit the timer setting.



The icon in the controller indicates as below:

 	Timer on every day
 ON	Timer on one time
No symbol	No timer setting

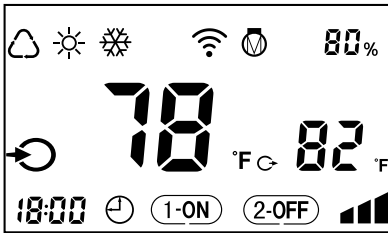
b) Timer off setting





1. Timer off flashing, press  to select timer off once / timer off cycle every day.

2. Press  or  to adjust the timing time, long press will increase or decrease rapidly.









3. Press  to confirm the operation and exit.

4. Press  to cancel the operation and exit the timer setting.

The icon in the controller indicates as below:

	2-OFF	Timer off every day
	OFF	Timer off one time
No symbol		No timer setting

After setting, the icon in the lower left corner indicates as below:

	1-ON	2-OFF	Timer on every day	Timer off every day
	1-ON	OFF	Timer on every day	Timer off one time
	1-ON		Timer on every day	No timer off
	ON	2-OFF	Timer on one time	Timer off every day
	ON	OFF	Timer on one time	Timer off one time
	ON		Timer on one time	No timer off
		2-OFF	No timer on	Timer off every day
		OFF	No timer on	Timer off one time
No symbol			No timer on	No timer off

IX. Testing

1. Inspection before use

- A. Check installation of the entire heater and pipe connections according to the pipe connecting drawing;
- B. Check the electric wiring according to the electric wiring diagram; and grounding connection;
- C. Make sure that the main heater power switch is off;
- D. Check the temperature setting;
- E. Check the air inlet and outlet.

2. Trial

- A. The user must start the water pump before the heat pump, and turn off the heat pump before the water pump, or the heat pump could be damaged;
- B. The user should start the water pump, and check for any leakage of water. Power the heat pump on by pressing the ON/OFF button of the heat pump, and set suitable temperature in the thermostat.
- C. In order to lower the electrical surcharge, the heater is equipped with a timer delayed starting function. When starting the heater; the fan will start 1 minute earlier than the compressor;
- D. After the pool heat pump starts up, check for any abnormal noise from the heater.

X. Precautions

1. Attention

- A. Set proper temperature in order to get comfortable water temperature. Avoid overheating.
- B. Do not stack substances that can block air flow near inlet or outlet area as the efficiency of the heater will be reduced or even stopped.
- C. Do not put hands near the water outlet in the swimming pool, and don't remove the screen of the fan at any time;
- D. If there are abnormal conditions such as noise, smell, smoke, electrical issues or leakage, please switch off the machine immediately and contact the local dealer or Support. Don't try to

repair it yourself;

- E. Don't use or stock combustible gas or liquid such as thinners, paint and fuel to avoid fire;
- F. In order to optimize the heating effect, please install heat preservation insulation on pipes between swimming pool and the heater. During running period of the swimming pool heater, please use a recommended cover on the swimming pool;
- G. Connecting pipes of the swimming pool and the heater should be ≤ 393.7 in, or the heating effect of the heater cannot be ensured;

2. Safety

- A. Please keep the main power supply switch far away from the children;
- B. When a power stoppage happens during running, and later the power is restored, the heater will start up automatically. So please switch off the power supply when there is a power cut, and reset temp when power is restored;
- C. Please switch off the main power supply in lightning and storm weather to prevent from machine damage that caused by lightning;
- D. If the machine is stopped for a long time, please cut off the power supply and drain water clear of the machine by opening the tap of inlet pipe and outlet pipe.

XI. Maintenance

Caution: Danger of electric shock

1. "Cut off" power supply of the heater before cleaning, examination and repairing
2. Do not touch the electronic components until the LED indication lights on PCB is off/ turn off.

A. In winter season or in the off-season

1. Cut off power supply to prevent any heater damage

2. Drain water clear of the heater.
3. Cover the heater body when not in use.

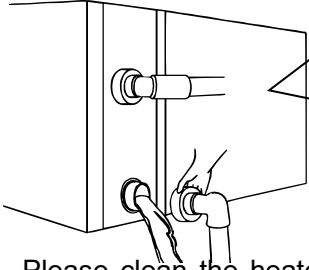

Important:
 Unscrew the water nozzle of inlet pipe to let the water flow out.
When the water in machine freezes in winter season, the titanium heat exchanger may be damaged. This is not covered on warranty.

- B. Please clean the heater's coil with household detergents or clean water, NEVER use gasoline, thinners or any similar fuel. This will ensure a good air flow.
- C. Check bolts, cables and connections regularly.

XII. Trouble shooting for common faults

Failure	Reason	Solution
Swimming pool heat pump does not run	No power	Wait until the power recovers
	Power switch is off	Switch on the power
	Fuse burned	Check to change the fuse
	The breaker is off	Check to turn on the breaker
Running but not heating	Air inlet blocked	Remove the obstacles
	Air outlet blocked	Remove the obstacles
	3minutes protection	Wait patiently
	Set temp too low	Set proper heating temperature
If the above solution doesn't work, please contact your dealer or Support Pool Products. Don't try to repair the heater yourself.		

Failure code

NO.	Display	Not failure description
-----	---------	-------------------------

1	E3	No water protection
2	E5	Power supply excesses operation range
3	E6	Excessive temp difference between inlet and outlet water(Insufficient water flow protection)
4	Eb	Ambient temperature too high or too low protection
5	Ed	Anti-freezing reminder
NO.	Display	Failure description
1	E1	High pressure protection
2	E2	Low pressure protection
3	E4	Phases lack protection (three phase model only)
4	E7	Water outlet temp too high or too low protection
5	E8	High exhaust temp protection
6	EA	Evaporator overheat protection (only at cooling mode)
7	P0	Controller communication failure
8	P1	Water inlet temp sensor failure
9	P2	Water outlet temp sensor failure
10	P3	Gas exhaust temp sensor failure
11	P4	Heating (Evaporator)coil pipe temp sensor
12	P5	Gas return temp sensor failure
13	P6	Cooling (Titanium heat exchanger) coil pipe temp sensor
14	P7	Ambient temp sensor failure
15	P8	Cooling plate sensor failure
16	P9	Current sensor failure
17	PA	Restart memory failure
18	F1	Compressor drive module failure
19	F2	PFC module failure
20	F3	Compressor start failure
21	F4	Compressor running failure
22	F5	Inverter board over current protection
23	F6	Inverter board overheat protection
24	F7	Current protection
25	F8	Cooling plate overheat protection
26	F9	Fan motor failure
27	Fb	Capacitor no charging protection
28	FA	PFC module over current protection

XIII. Wi-Fi Setting

4.1. APP Download

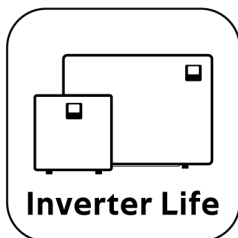

Android Mobile please download from

iPhone please download from

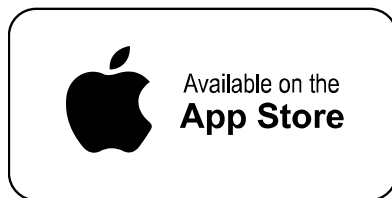

4.2. Account registration

a) Registration by Cell phone number/Email

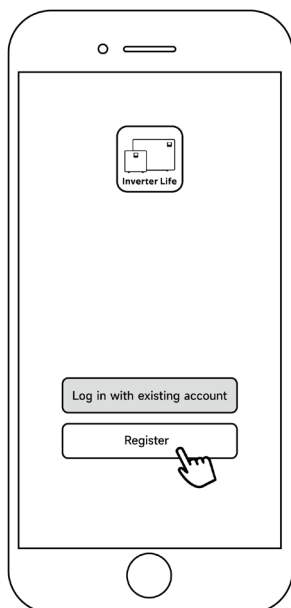

b) Cell phone number registration

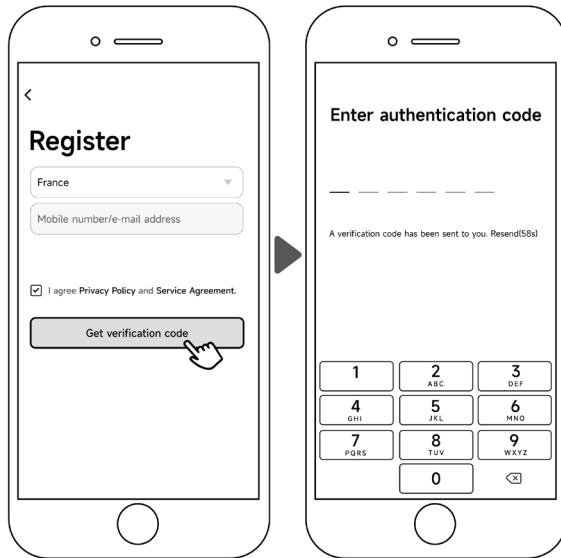

4.3. Create family

Please set a name for the family and choose the room of the device.

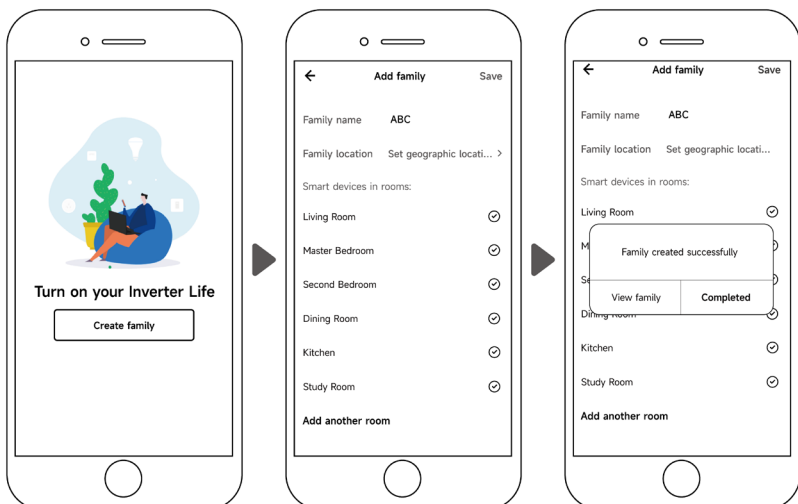

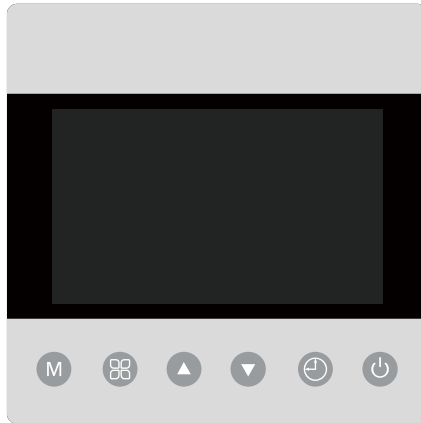

4.4. Three methods of device binding

Please connect your phone to the Wi-Fi network first.



4.4.1. Auto Discovery (Bluetooth)

- a) Please make sure the Bluetooth function is enabled on your phone.
- b) Press  for 3 seconds after the screen unlock,  will be flashing rapidly to enter Wi-Fi binding status.
- c) Click "Add Device", wait for the app to search for the device and then click "add", then follow the instructions below to finish the device binding.

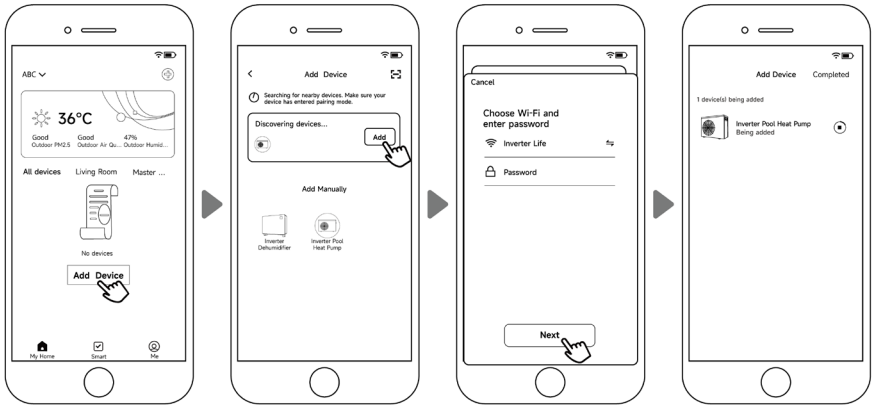



Note:

1. It will take some time to scan, please be patient.
2. Only Wi-Fi modules with Bluetooth functions can use this method.

4.4.2. EZ Mode (Easy-connect)

- a) Activate the Wi-Fi module

Press  for 3 seconds after the screen unlocks,  will be flashing rapidly to enter Wi-Fi binding status.

- b) Click "Add device", and follow the instructions below to finish binding.  display on the screen once the Wi-Fi connection success.

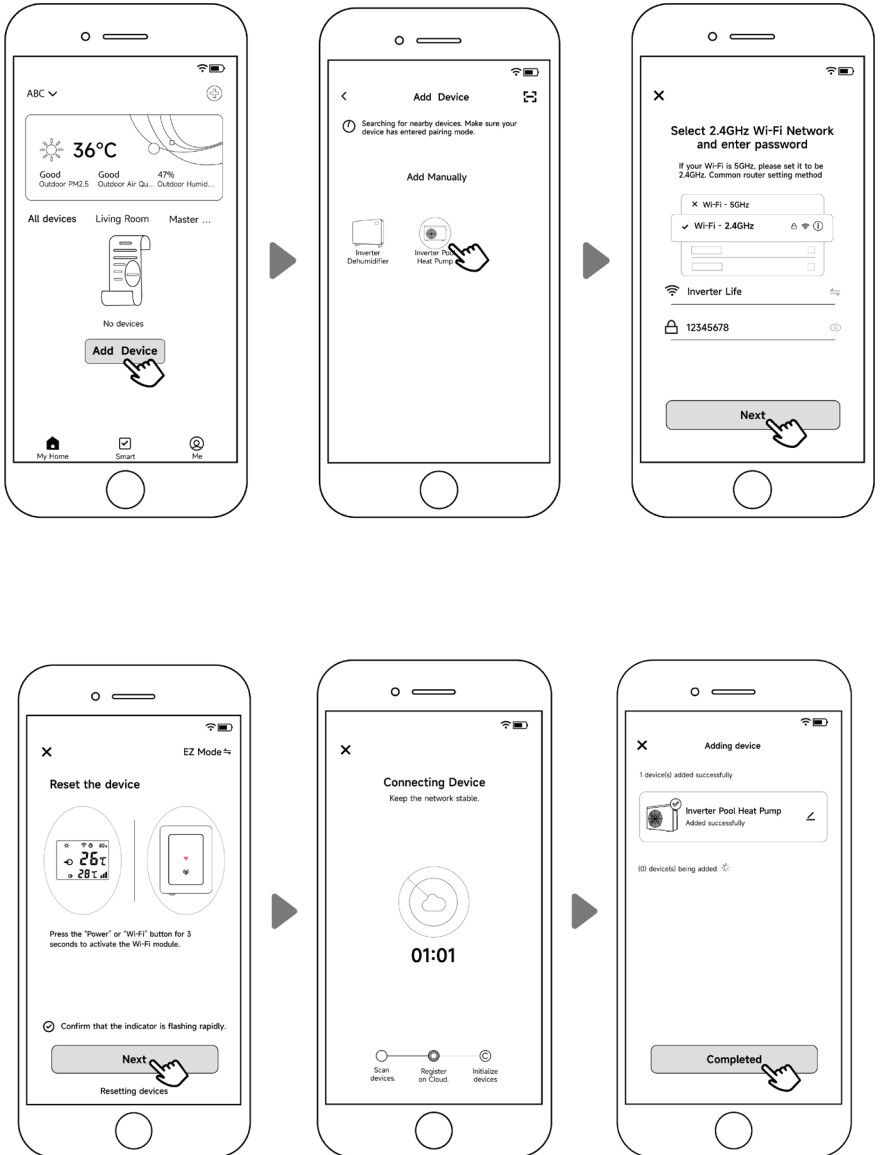



Note: After allowing the APP to locate, it can read the Wi-Fi name

automatically.

4.4.3. AP Mode

Activate Wi-Fi module

- a) Press  for 10 seconds after the screen unlock,  will be flashing slowly to enter Wi-Fi binding status.
- b) Click "Add device", and follow the instructions below to finish binding.  display on the screen once the Wi-Fi connection success.

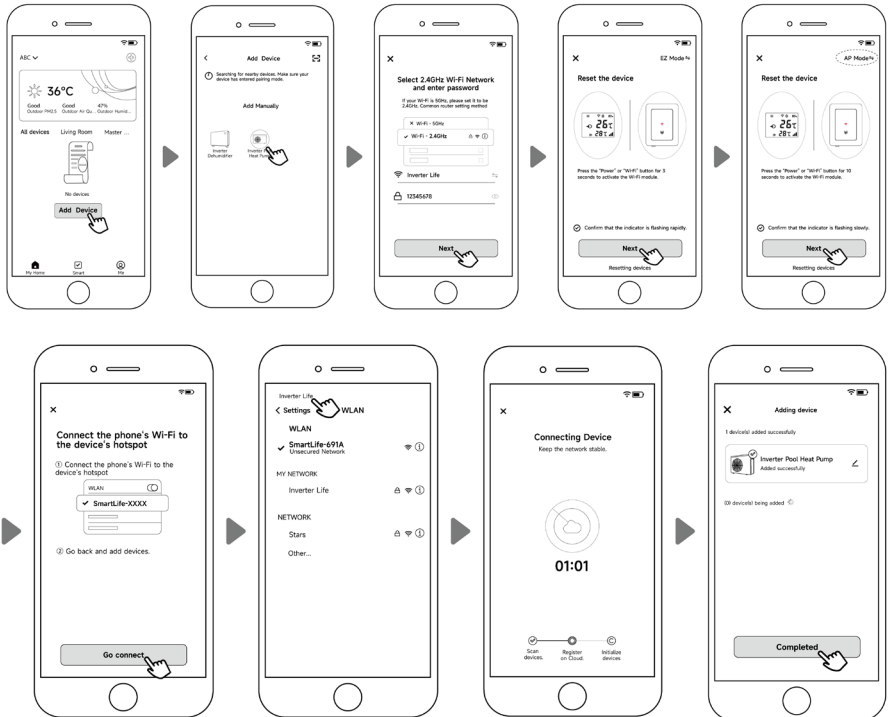

Note: If it doesn't jump automatically, click "Confirm hotspot connection, next".

4.4.4. If connect fails, please make sure your network name and password are correct. And your router, mobile phone and device are as close as possible.

4.4.5. Wi-Fi rebinding (When Wi-Fi password changes or network configuration changes)

Press  for 10 seconds,  will be flashing slowly for 60

seconds. Then  will be off. The original binding will be removed. Follow steps above for rebinding.

Remarks: Please make sure the router is configured at 2.4 GHz.

4.5. Operation instructions

The following instructions are for heat pumps with heating and cooling functions.

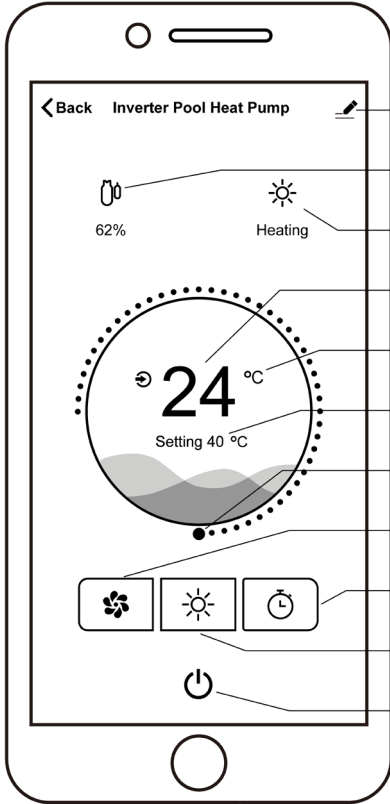

- More \Rightarrow share device
- Heating capacity percentage
- Indicate the working status
- The current swimming pool water temp
- Switching °C/°F
- Setting temp
- Temp adjustment slider
- Smart/Silence Selection
- Cloud Timer
- Heating/Cooling/Auto Selection
- ON/OFF

4.6. Share devices with your family members

After binding, if your family members also want to control the device.

Please let your family members register the APP first, and then the administrator can operate as below (The following pictures are for reference only):

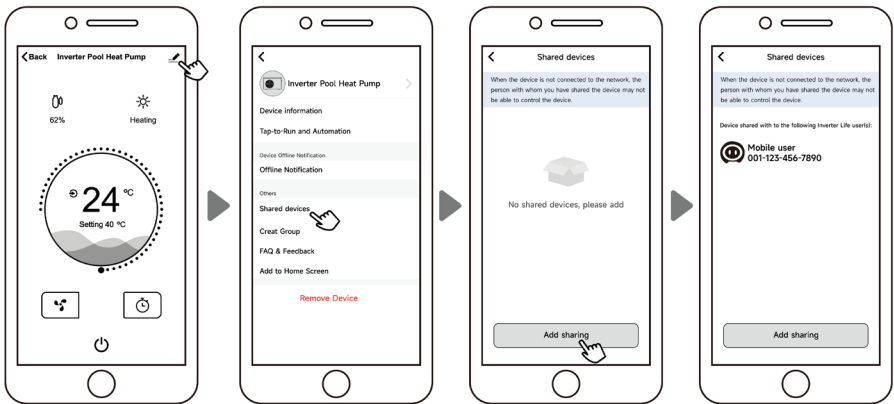

Then your family members will see this heat pump once they log in to the APP.

Notice: 1. The weather forecast is just for reference.

2. APP is subject to update without notice.

The factory reserves the final interpretation right.

And keep the right to stop or change product specification and design without prior notice at any time, no need to bear the resulting obligations.

XIV. Warranty & After-Service

Infinity Living products warranty is managed by Moov Pool Products. Please note Infinity Living products are not a brand owned by Moov Pool Products. Only Infinity Living products listed above are managed by Moov Pool Products. Warranty begins at time of purchase. Warranty is only valid upon first install.

Some claims will not be approved under any circumstances by Moov Pool Products. Such claims include and are not limited to:

- Heat Exchanger broken due to water left in through improper winterization. Appropriate winterization can be found on page 15 of this manual. Any other winterization default claims will be refused.
- Heat Pump damaged by meteorological events such Hurricanes, Tornados, Hail, Earthquakes and any other act of god event.
- Units not installed by an appropriate technician. The trade job of these technicians will vary depending on the region of the install and can include HVAC technicians or electricians. Electrical wiring or product manipulations are included.
- Any unsatisfactory claim. Heat Pumps efficiency will vary depending on various factors such as outdoor temperature, required temperature, air flow, sun presence, humidity, pool sizing, heat pump distance from the pool and much more. Please always refer to your pool expert to select the right unit tailored to your needs or contact Moov Pool Products for a recommendation.

All warranty claims must be approved by an authorized Moov Pool Products employee. For more information on warranties or to submit a claim, contact Moov Pool Products.

Moov Pool Products Inc

Head office located in Orlando, Florida, USA

www.moovpool.com / (407)-559-2077

The factory reserves the final interpretation right and keep the right to stop or change product specification and design without prior notice at any time, no need to bear the resulting obligations.

Infinity Living

The design and specifications are subject to change without prior notice for product improvement. Consult with the sales agency or manufacturer for details. Any updates to the manual will be uploaded to the service website, please check for the latest version.